



Gasolec Orion Horizontal Light Units

HLU



HLUDA

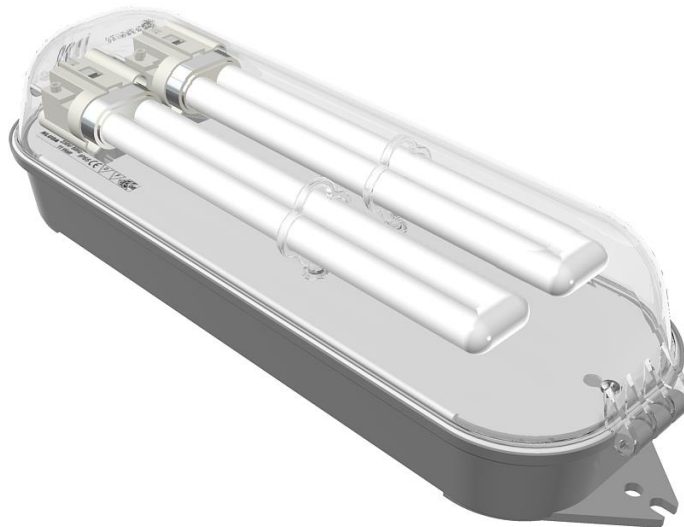







<i>Gasolec HLU</i>	2
<i>Gasolec HLUDA</i>	6





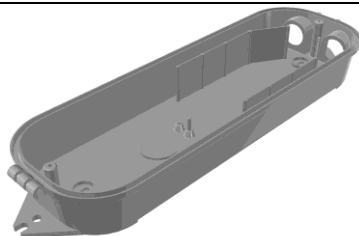
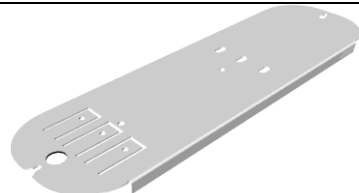

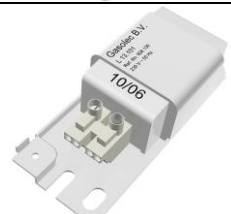
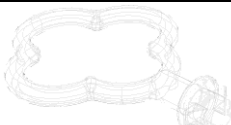



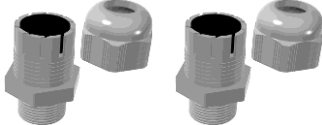

Gasolec Orion HLU



Gasolec Orion HLU

Gasolec Code No.	#	Description:	
LP001 Up to and including LP004	1	Orionlux Lamps	<p>Orionlux 11 Watt</p>  <p> ■ (red) ■ (blue) ■ (green) (white) </p> <p> LP001 LP002 LP003 LP004 </p>
LP080	1	HLU Top	
LP081	1	HLU Bottom	
LP085	1	HLU Reflector	
LP091	1	HLU Sealing	
LP095	1	HLU Lamp Holder	
LP100	2	HLU Ballast 50 Hz	
LP105	1	HLU Lamp Key	
LP108	1	Carry-out rubber Gummi 10mm white	







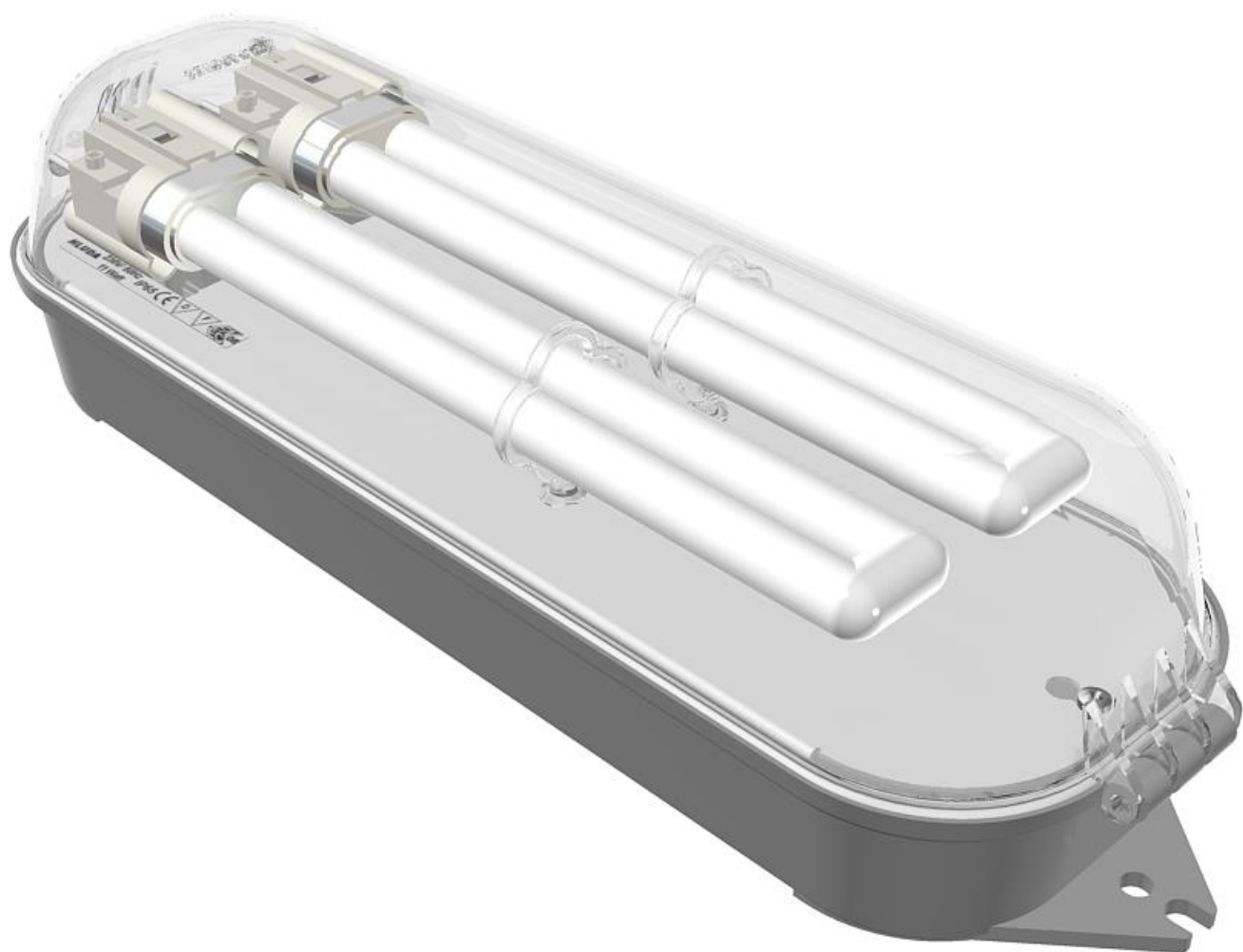

LP110	1	HLU Connection Block 3x	
LP112	2	Cable gland (M16x1,5) complete	
LP113	2	Nut cable gland (116/M16)	
LP120	0,63 Mtr	Heat resistant wire 1mm ² , >150°C	
LP121	0,17 Mtr	Heat resistant wire 1mm ² , >150°C (ground)	
LP150	1	Parker 2,9x16mm	
LP151	2	Parker 2,9x6,5mm	
LP152	1	Screw M4x4	
LP910	1	Sticker CE HLU	
PU034	2	Toothed Lock Washer, External teeth M4	
PU370	2	Rivet Stainless Steel Ø4	
PU371	1	Rivet, Inox A2 3,2 x 6	



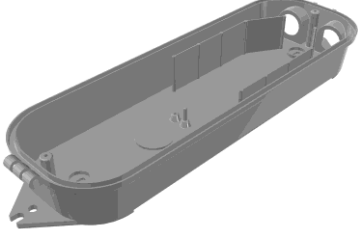
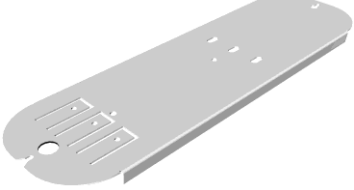

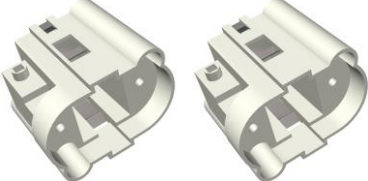





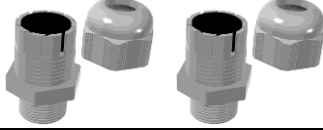

Gasolec Orion HLUDA



Gasolec Orion HLU DA

Gasolec Code Nr.	#	Description:	
LP001 Up to and including LP004	2	Orionlux Lamps	<p>Orionlux 11 Watt</p>  <p> ■ (red) ■ (blue) ■ (green) (white) LP001 LP002 LP003 LP004 </p>
LP080	1	HLU Top	
LP081	1	HLU Bottom	
LP085	1	HLU Reflector	
LP091	1	HLU Sealing	
LP095	2	HLU Lamp Holder	
LP100	1	HLU Ballast 50 Hz	
LP105	2	HLU Lamp Key	
LP108	1	Carry-out rubber Gummi 10mm white	

LP110	1	HLU Connection Block 4x	
LP112	2	Cable gland (M16x1,5) complete	
LP113	2	Nut cable gland (116/M16)	
LP120	0,63 Mtr	Heat resistant wire 1mm ² , >150°C	
LP121	0,17 Mtr	Heat resistant wire 1mm ² , >150°C (ground)	
LP150	1	Parker 2,9x16mm	
LP151	2	Parker 2,9x6,5mm	
LP152	1	Screw M4x4	
LP912	1	Sticker HLU DA	
PU034	2	Toothed Lock Washer, External teeth M4	
PU370	2	Rivet Stainless Steel Ø4	
PU371	1	Rivet, Inox A2 3,2 x 6	