

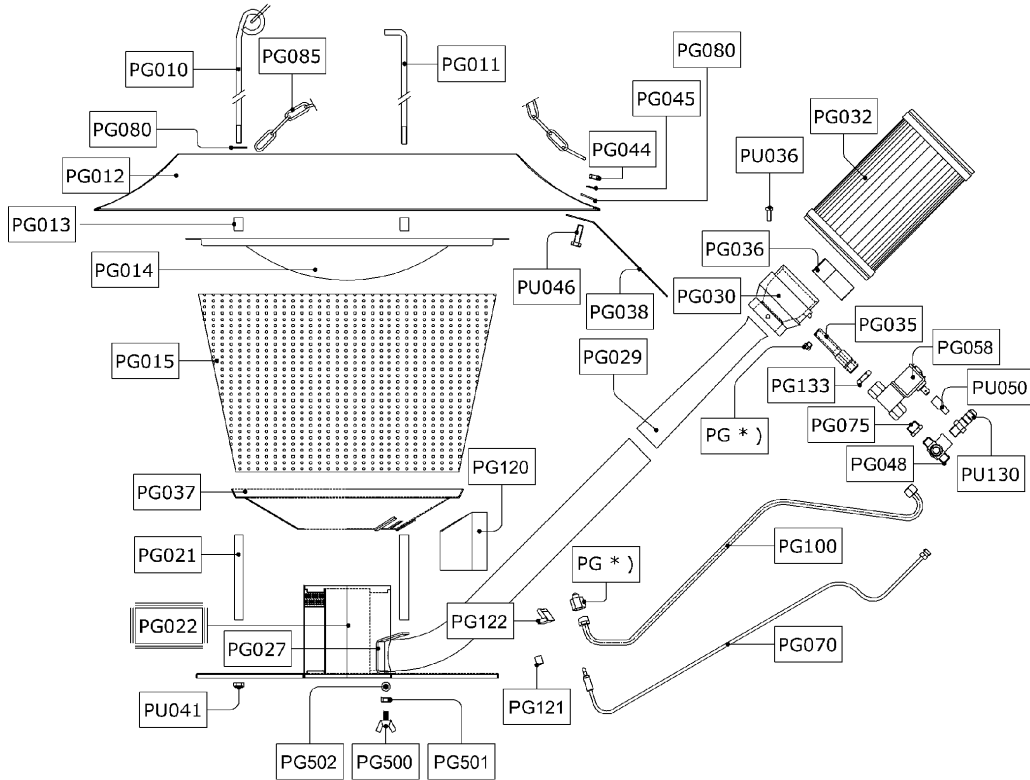

G12 Asco



A G12 Asco



B G12 Asco

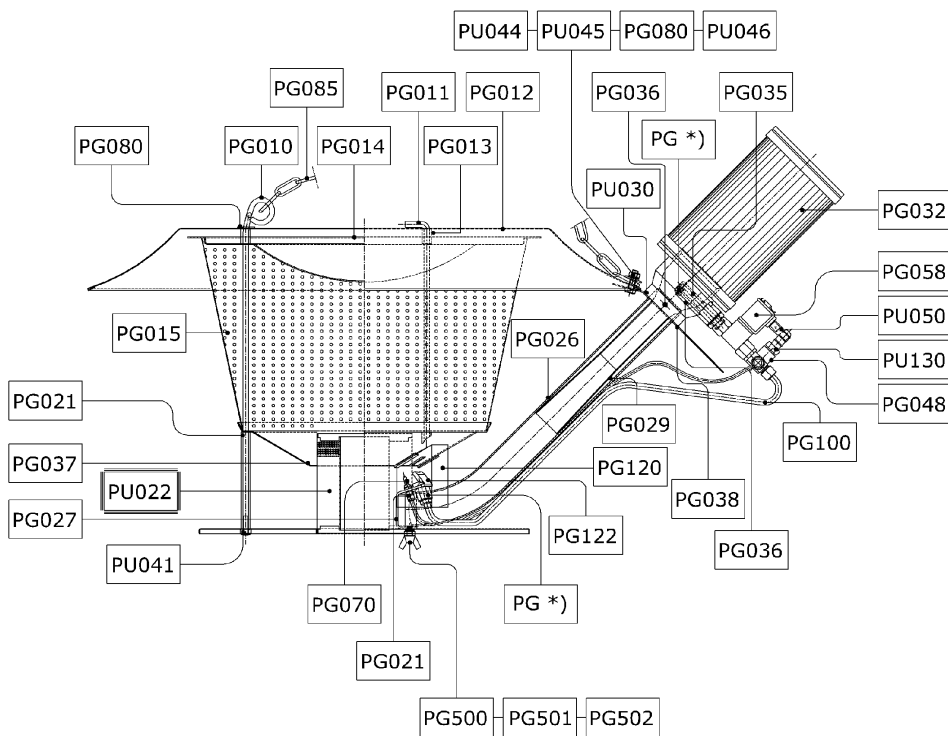

Infrared Heater G12 Asco

Parts List G12 Asco











Part:	#	Description:	Old Reference:
PG *)	1	Pilot Jet G12 Ø depends on gas type and pressure	73
PG *)	1	Jet G12 Ø depends on gas type and pressure	63
PG010	1	Connecting Eye Rod	51
PG011	2	Connecting Rod	52
PG012	1	Reflector G	53
PG013	3	Short Spacer 10*12mm	54
PG014	1	Emitter Top Plate	55
PG015	1	Emitter G12	56
PG021	3	Long Spacer 10*100mm	58
PG022	1	Burner Unit G12	59
PG027	1	Pilot Flame Bracket G12	-
PG029	1	Venturi G12	60
PG030	1	Adapter	61
PG032	1	Filter G Heavy Duty	62
PG035	1	Jet Holder G12 G1/4 Asco/Maxi	64
PG036	1	Jet Retainer	65
PG037	1	Emitter Bottom Plate Asco/Max/Hon	57
PG038	1	Burner pipe Support Asco	80
PG058	1	Solenoid Asco 230 Vac/12Vdc	66
PG062	1	Solenoid Asco 110-115 Vac	-
PG040	1	Solenoid Asco 24Vac/12Vdc	-
PG048	1	OP Safety Device G12	68
PG070	1	Thermocouple 600 mm G12 Asco/Maxi	69
PG075	1	Bushing 1/4" x 1/8"	67
PG080	2	Washer 3D M6 (for Chain)	74
PG085	1	Chain	75
PG100	1	Pilot Gas pipe G12 Asco Complete	70
PG120	1	Pilot Cover	71
PG121	1	Thermocouple Holder G **)	72
PG122	1	Flame Guide G12 **)	59e
PG133	1	Brass fixation nut 1/4" G	none
PG500	1	Wing Screw **)	-
PG501	1	Nylock M5 **)	-
PG502	1	Spring Ring M5 **)	-
PU036	1	Screw Stainless M5x10	84
PU041	3	Nylock Nut M6	76
PU044	1	Nut M6	81
PU045	1	Spring Lock Washer M6	82
PU046	1	Bolt self tapping M6x16	78
PU050	2	Cable Shoe Red	none
PU117	1	Magnetic Coil Small	-
PU130	1	Hose Barb 9 mm 1/8"G	83

PG *) Depends on gas type and pressure.

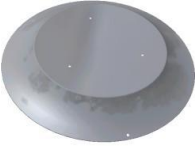



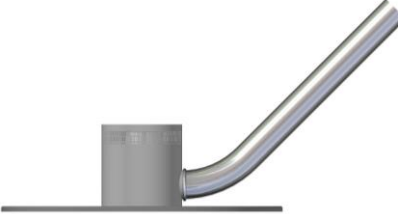









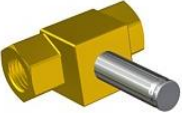

****) When ordering PG022 complete, you also need to order these five parts!**

Infrared Heater G12 Asco



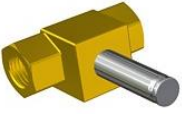



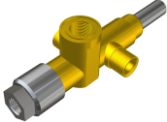

Drawings Parts

PG *)	Main Jet Depends on pressure and gas type	
PG *)	Pilot Jet Depends on pressure and gas type	
PG010	Connecting Eye Rod	
PG011	Connecting Rod	
PG012	Reflector G	
PG013	Short spacer	
PG014	Emitter Top plate	
PG015	Emitter G12	
PG021	Long spacer	
PG022	Burner Unit G12	
PG500 + PG501 + PG502	Wing screw M5x10 + Nylock M5 + Spring ring M5	





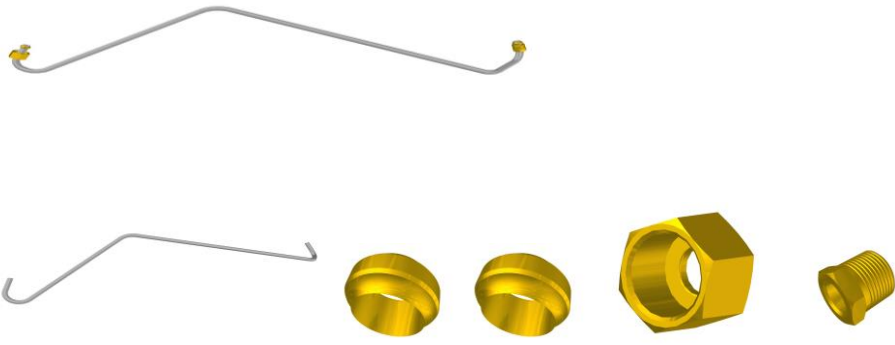





Infrared Heater G12 Asco

PG027	Pilot Flame Bracket G12	
PG029	Venturi G12	
PG030	Adapter	
PG032	Heavy Duty Dust Filter	
PG035	Jet Holder G12	
PG036	Jet Retainer	
PG037	Emitter Bottom plate	
PG038	Burner pipe Support	
PG058	Solenoid Asco 230 Vac	   
OR		PG045 + PG043 + PG061 + PG057
PG062	Solenoid Asco 110-115 Vac	   
		PG045 + PG041 + PG061 + PG057

Infrared Heater G12 Asco

<p>OR</p> <p>PG040</p>	<p>Solenoid Asco 24Vac/12Vdc</p>	 <p style="text-align: center;">PG045 + PG074 + PG061 + 2x PG050</p>
<p>PG048</p>	<p>Safety Device Asco OP</p>	
<p>PG075</p>	<p>Bushing 1/4" x 1/8"</p>	
<p>PU117</p>	<p>Magnetic Coil Small</p>	
<p>PG070</p>	<p>Thermocouple 600mm Asco</p>	
<p>PG080</p>	<p>Washer 3D M6</p>	
<p>PG085</p>	<p>Chain</p>	
<p>PG100</p> <p>PG090 + PG110 (2x) + PG111 + PG112</p>	<p>Pilot Gas pipe complete</p> <p>Pilot Gas pipe (2x)</p> <p>Grip ring Pilot Gas pipe (2x)</p> <p>Grip screw Pilot Gas pipe</p> <p>Swivel Pilot Gas pipe</p>	 <p style="text-align: center;">PG090 + 2x PG110 + PG111 + PG112</p>
<p>PG120</p>	<p>Pilot Cover</p>	
<p>PG121</p>	<p>Thermocouple Holder</p>	

Infrared Heater G12 Asco

PG122	Pilot Flame Guide	
PG133	Brass fixation nut 1/4" G	
PU036	Screw M5x10	
PU041	Nylock Nut M6	
PU044	Nut M6	
PU045	Spring ring M6	
PU046	Bolt M6x16 self tapping	
PU130	Hose barb 9 mm 1/8" G	
PU129	Hose barb 11 mm 1/8" G	
PU131	Hose barb 8 mm smooth 1/8" G	
PU137	Hose connection Double nipple 1/8" - 3/8"	