

## Infrared Heaters Type S

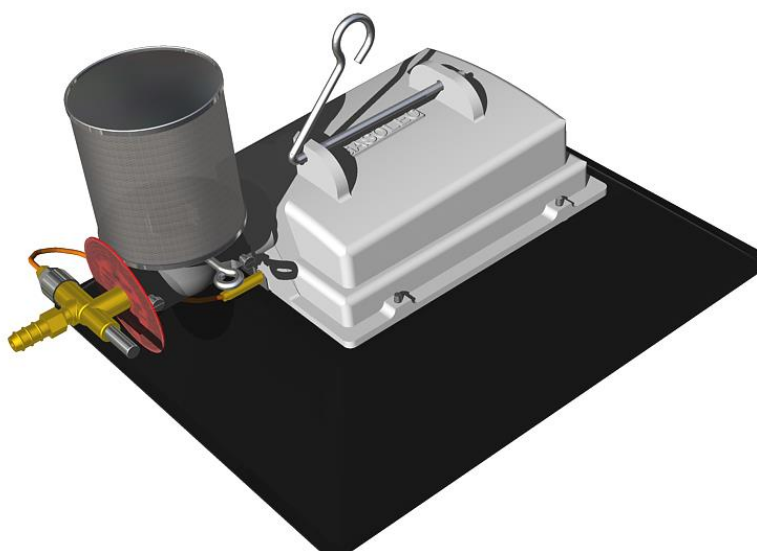

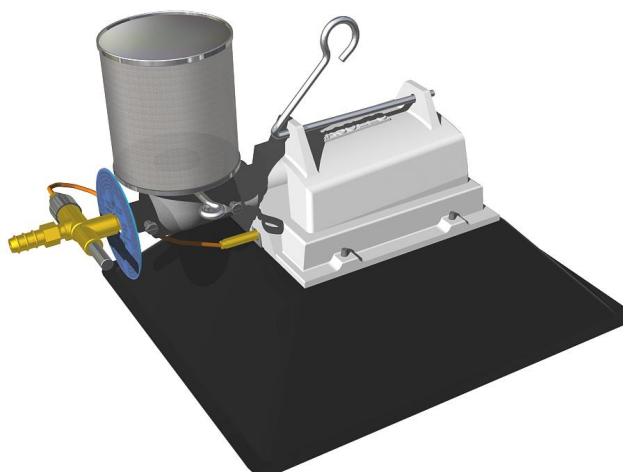

<b>INFRARED HEATER S2</b>	<b>3</b>
<b>INFRARED HEATER S4</b>	<b>9</b>
<b>INFRARED HEATER S8</b>	<b>15</b>



## Infrared Heater S2

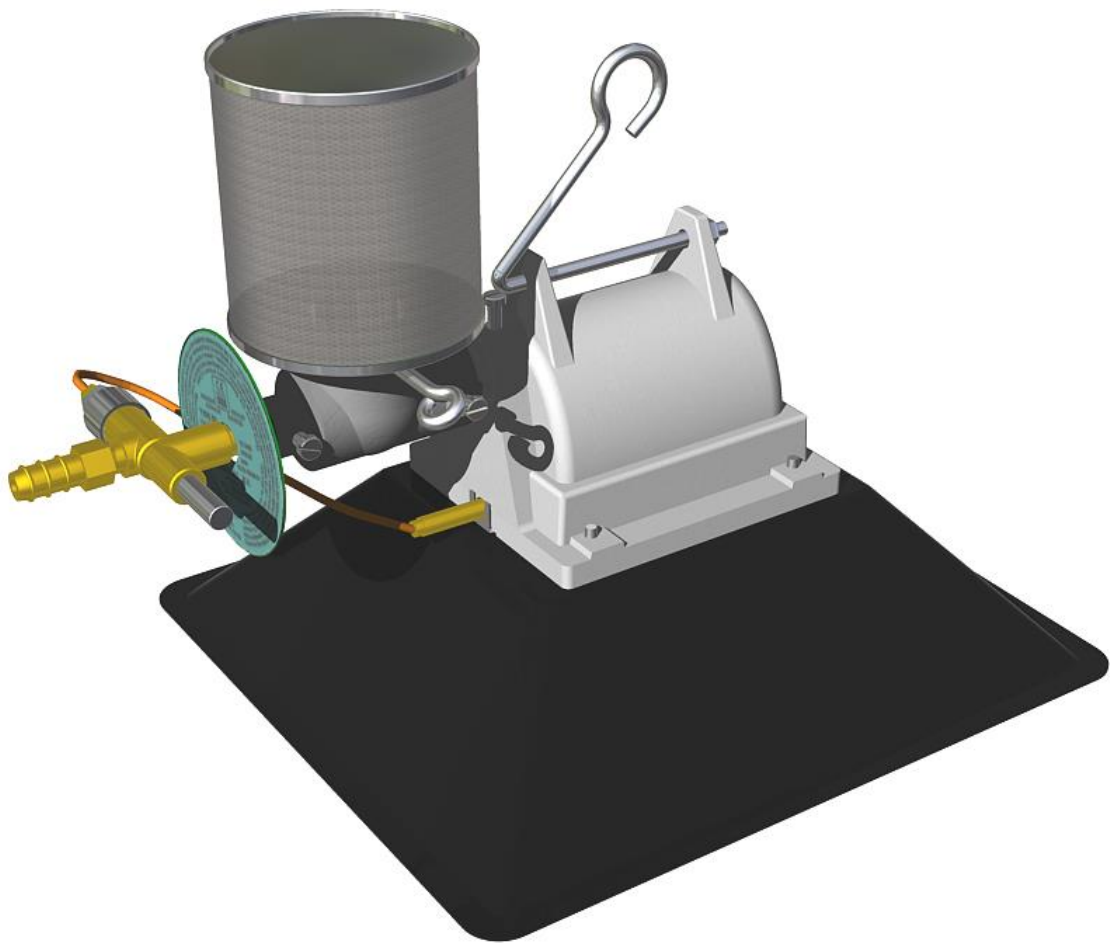

# Infrared Heater S2

**A**

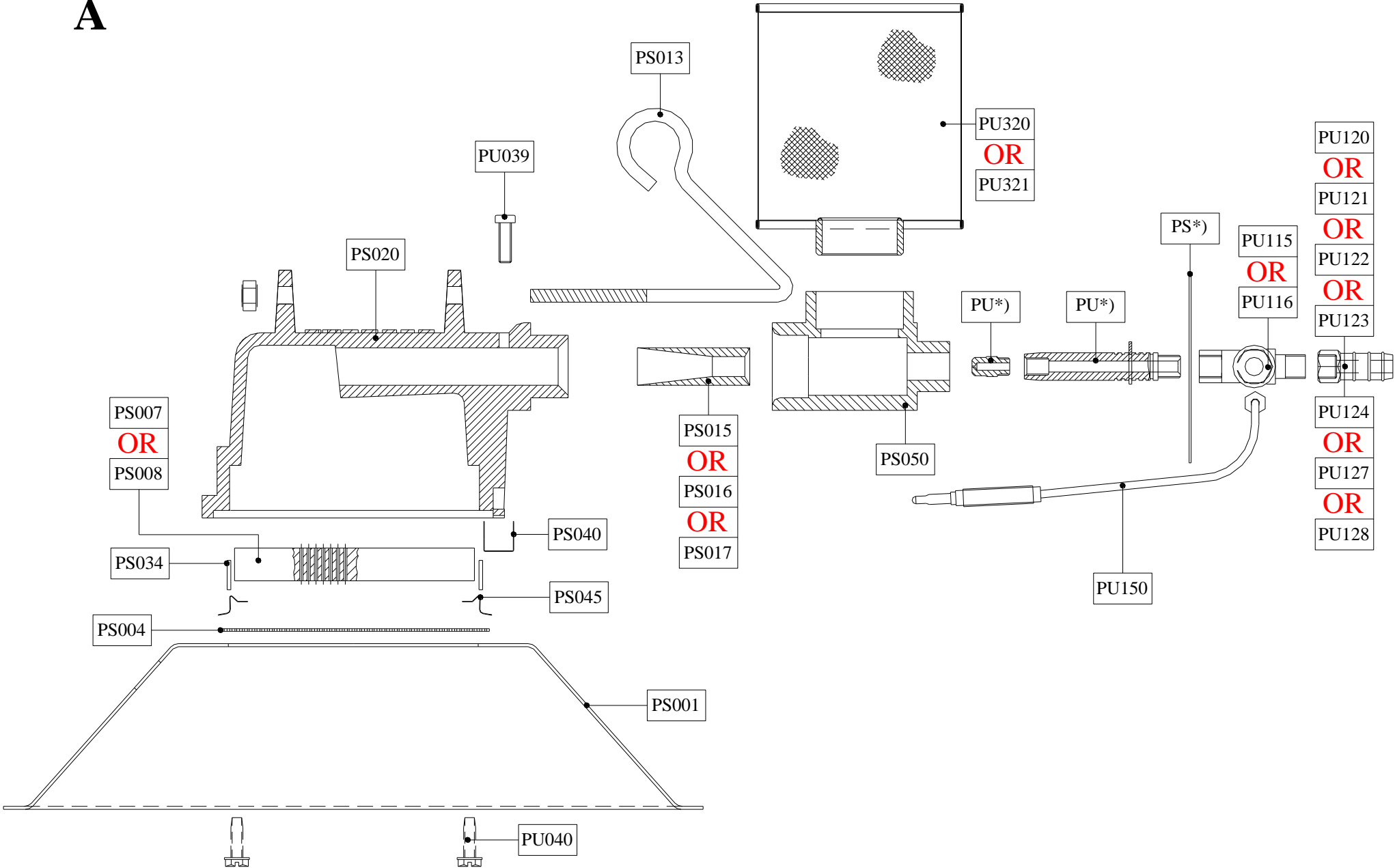

Infrared Heater S2

**B**

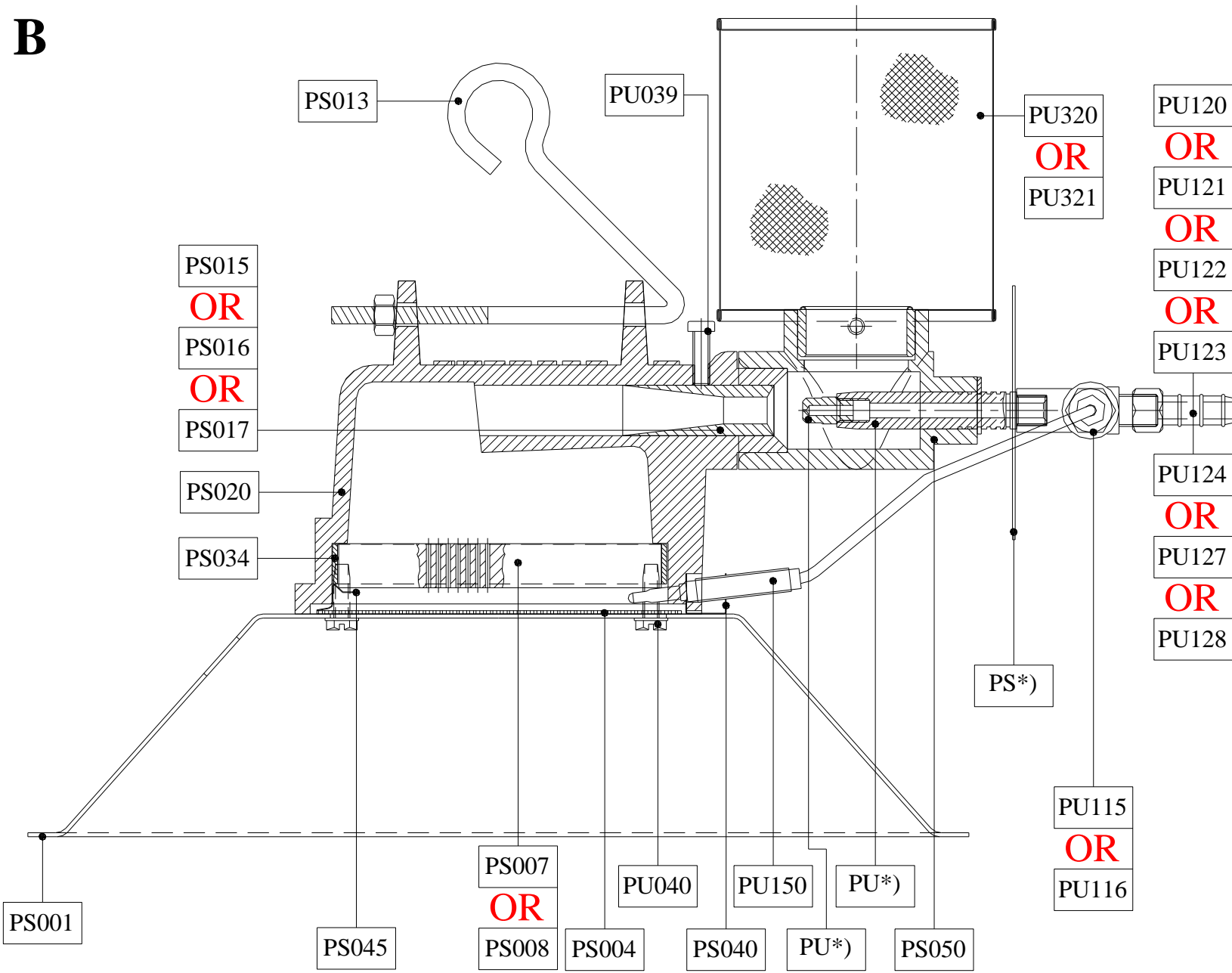

## Parts List S2













Part:	#	Description:	Old Reference:
PU*)	1	Jet S/M, depends on gas type and pressure	9
PU*)	1	Jet Holder S/M, depends on gas type and pressure	10
PS*)	1	Marking Plate S2, depends on gas type and pressure	20
PS001	1	Reflector S2	1
PS004	1	Steel Grid S2	3
PS007** Or PS008**	1	Ceramic Burner Plate S2 Ø1,05mm** Ceramic Burner Plate S2 Ø1,30mm**	4
PS013	1	Suspension Hook S2 including Nut	6
PS015** Or PS016** Or PS017**	1	Venturi Ø15x6** Venturi Ø15x8** Venturi Ø15x11**	16
PS020	1	Burner House S2	5
PS034	1	Set Frame Lists S2	18
PS040	1	Thermocouple Clip S	19
PS045	2	Stone Clip	17
PS050	1	T-piece normal (S types) Incl. 2x PU036 - Screw M5x10 Incl. 1x PU038 - Thumb Screw T-piece M5x30x8	14
PU039	1	Screw M5x16	7
PU040	4	Parker Screw self Tapping	2
PU115  Or PU116	1	Safety Device without Hose Socket Incl. PU117 - Interior Coil Small  Safety Device with Hose Socket Incl. PU117 - Interior Coil Small	11
PU120 Or PU121 Or PU122 Or PU123 Or PU124 Or PU126 Or PU127 Or PU128	1	Hose Socket 1/8"F 9mm Hose Socket 1/8"F 11mm Hose Socket 1/8"F 8mm smooth Bushing 1/8"F*3/8"M Bushing 1/8"F*1/2"M Hose Barb Spanish Special Connection Japan CGA Connection	12
PU150	1	Thermocouple L=220	15
PU320 Or PU321	1	Stainless Steel Filter standard M/S Filter M/S Heavy Duty	8

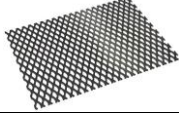
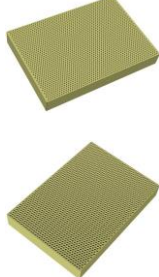



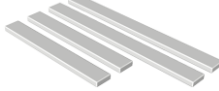

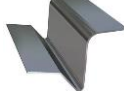







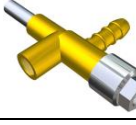

### NOTES:

**PU \*) & PS \*):** Depends on gas type and pressure.

**\*\*:** This also depends on gas type and pressure!

## Infrared Heater S2 Position Numbers

PU*)	Jet S/M, depends on gas type and pressure	
PU*)	Jet Holder S/M, depends on gas type and pressure	
PS*)	Marking Plate S2, depends on gas type and pressure	
PS001	Reflector S2	
PS004	Steel Grid S2	
PS007** Or PS008**	Ceramic Burner Plate S2 Ø1,05mm**  Ceramic Burner Plate S2 Ø1,30mm**	
PS013	Suspension Hook S2 including Nut	
PS015** Or PS016** Or PS017**	Venturi Ø15x6**  Venturi Ø15x8**  Venturi Ø15x11**	
PS020	Burner House S2	
PS034	Set Frame Lists S2	
PS040	Thermocouple Clip S	
PS045	Stone Clip	
PS050	T-piece normal (S types) Incl. 2x PU036 - Screw M5x10 Incl. 1x PU038 - Thumb Screw T-piece M5x30x8	

PU039	Screw M5x16	
PU040	Parker Screw self Tapping	
PU115 Or	Safety Device without Hose Socket Incl. PU117 - Interior Coil Small	 incl. 
PU116	Safety Device with Hose Socket Incl. PU117 - Interior Coil Small	 incl. 
PU117	Magnetic Coil Small	
PU120 Or	Hose Socket 1/8"F 9mm	
PU121 Or	Hose Socket 1/8"F 11mm	
PU122 Or	Hose Socket 1/8"F 8mm smooth	
PU123 Or	Bushing 1/8"F*3/8"M	
PU124 Or	Bushing 1/8"F*1/2"M	
PU127 Or	Special Connection Japan	
PU128	CGA Connection	
PU150	Thermocouple L=220	
PU320 Or	Stainless Steel Filter standard M/S	
PU321	Filter M/S Heavy Duty	





## Infrared Heater S4

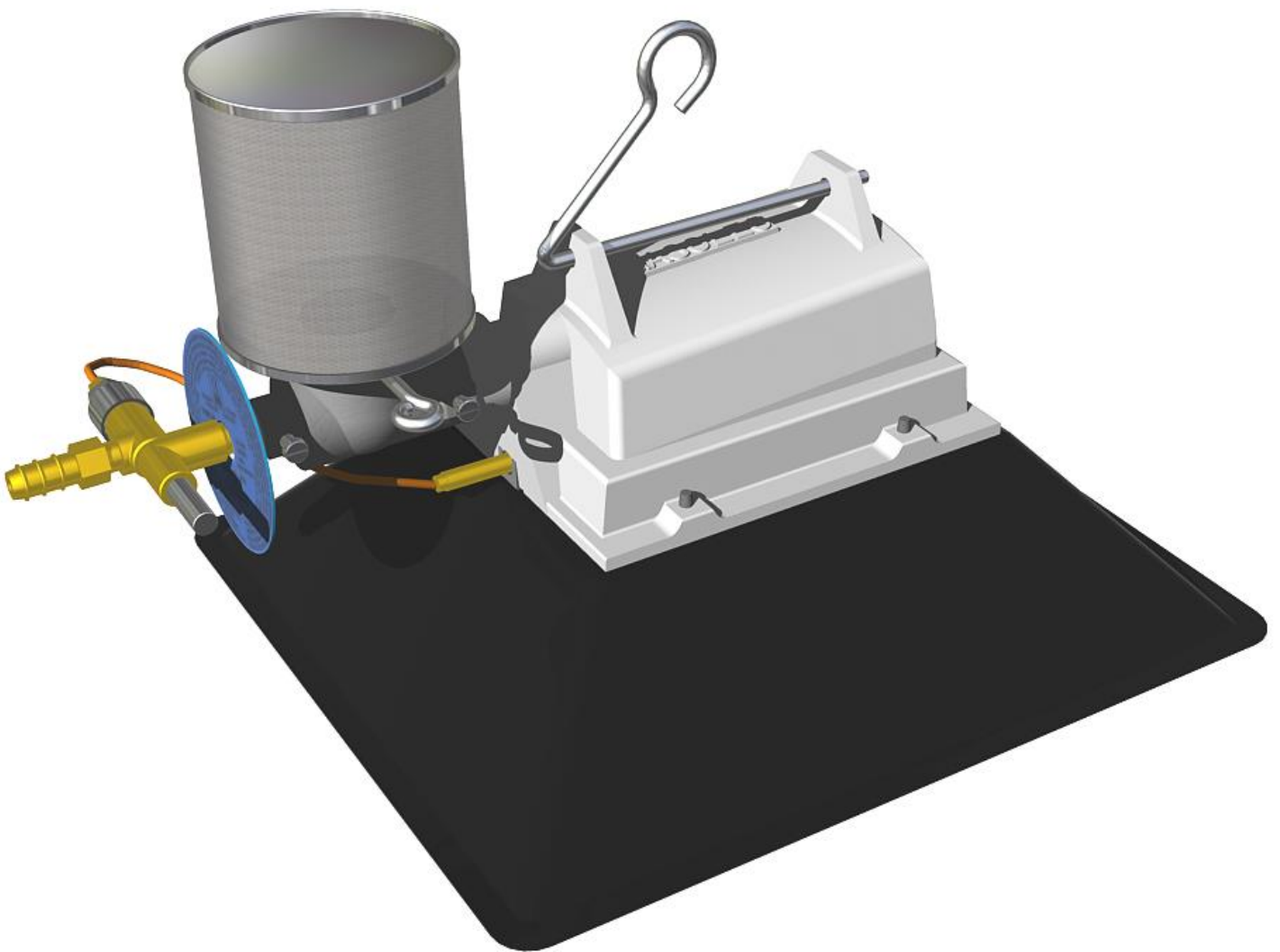

# Infrared Heater S4

**A**

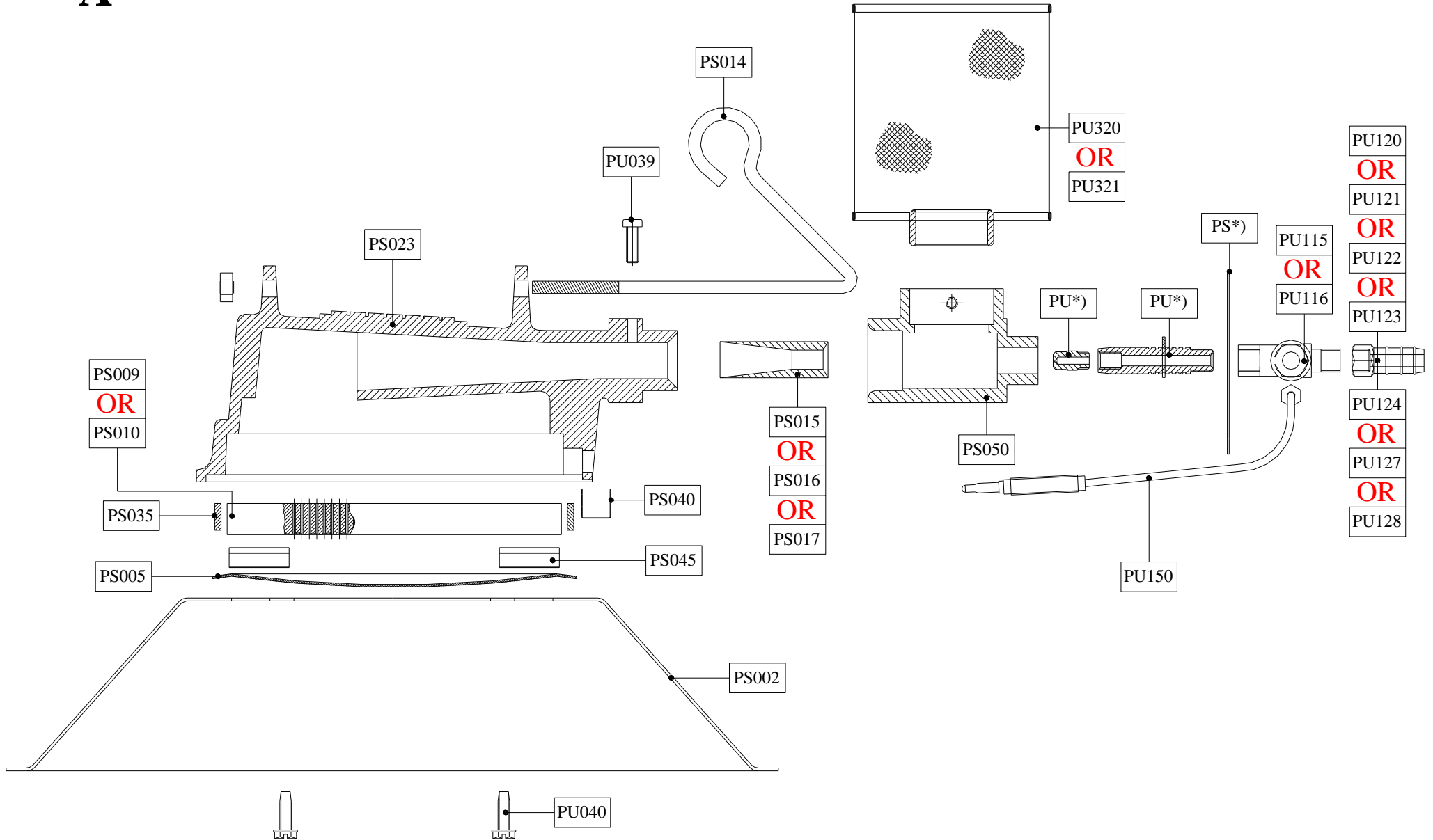

# Infrared Heater S4

**B**

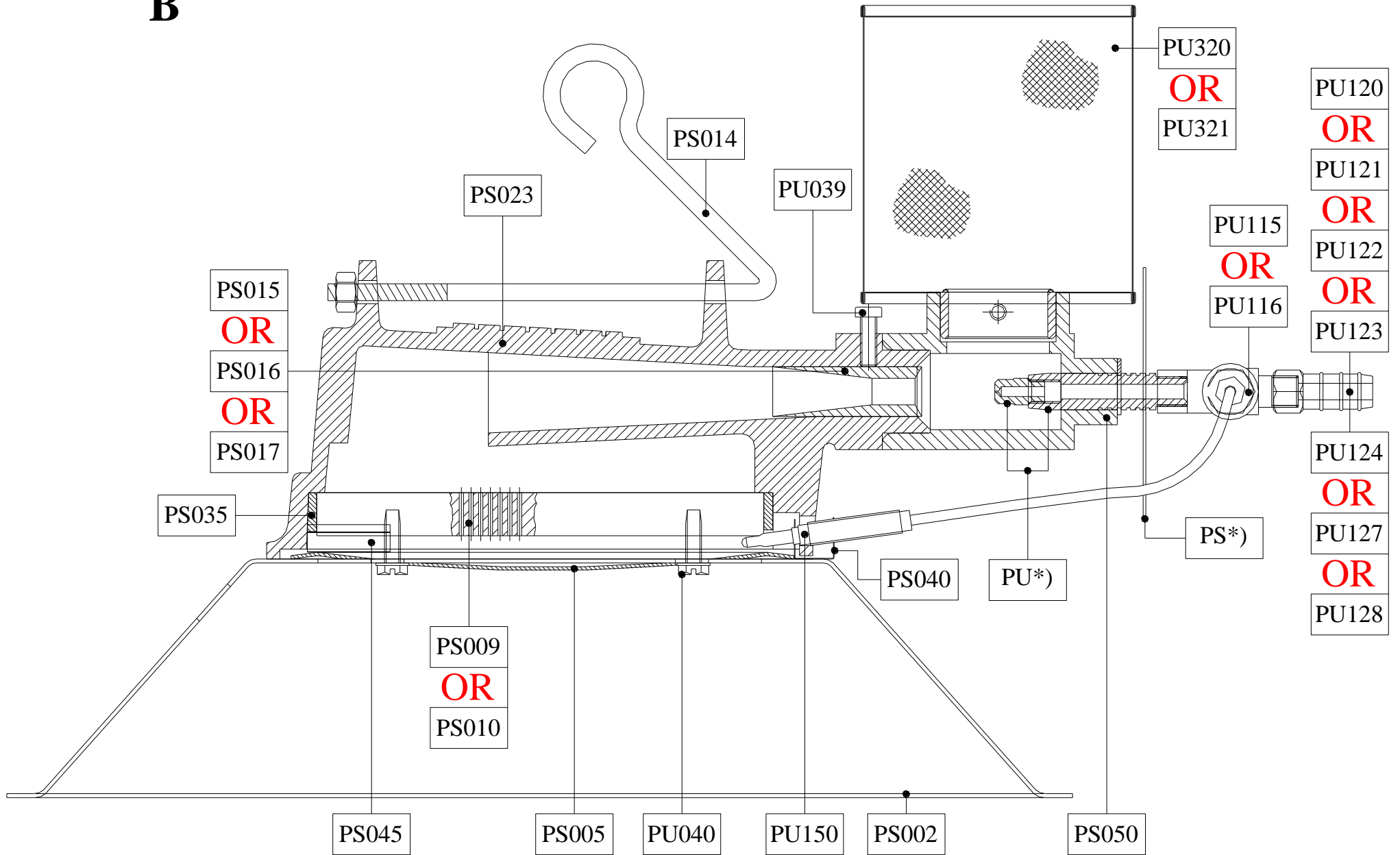

### Parts List S4

Part:	#	Description:	Old Reference:
PU*)	1	Jet S/M, depends on gas type and pressure	9
PU*)	1	Jet Holder S/M, depends on gas type and pressure	10
PS*)	1	Marking Plate S4, depends on gas type and pressure	20
PS002	1	Reflector S4	1
PS005	1	Steel Grid S4	3
PS009** Or PS010**	1	Ceramic Burner Plate S4 Ø1,0mm** Ceramic Burner Plate S4 Ø1,30mm**	4
PS014	1	Suspension Hook S4 including Nut	6
PS015** Or PS016** Or PS017**	1	Venturi Ø15x6** Venturi Ø15x8** Venturi Ø15x11**	16
PS023	1	Burner House S4 Gasolec	5
PS035	1	Set Frame Lists S4	18
PS040	1	Thermocouple Clip S	19
PS045	2	Stone Clip	17
PS050	1	T-piece normal (S types) Incl. 2x PU036 - Screw M5x10 Incl. 1x PU038 - Thumb Screw T-piece M5x30x8	14
PU039	1	Screw M5x16	7
PU040	4	Parker Screw self Tapping	2
PU115  Or PU116	1	Safety Device without Hose Socket Incl. PU117 - Interior Coil Small  Safety Device with Hose Socket Incl. PU117 - Interior Coil Small	11
PU120 Or PU121 Or PU122 Or PU123 Or PU124 Or PU127 Or PU128	1	Hose Socket 1/8"F 9mm Hose Socket 1/8"F 11mm Hose Socket 1/8"F 8mm smooth Bushing 1/8"F*3/8"M Bushing 1/8"F*1/2"M Special Connection Japan CGA Connection	12
PU150	1	Thermocouple L=220	15
PU320 Or PU321	1	Stainless Steel Filter standard M/S Filter M/S Heavy Duty	8





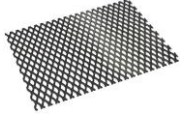

### NOTES:

**PU \*) & PS \*):** Depends on gas type and pressure.

**\*\*:** This also depends on gas type and pressure!

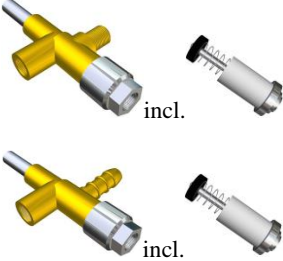
## Infrared Heater S4 Position Numbers

PU*)	Jet S/M, depends on gas type and pressure	
PU*)	Jet Holder S/M, depends on gas type and pressure	
PS*)	Marking Plate S4, depends on gas type and pressure	
PS002	Reflector S4	
PS005	Steel Grid S4	
PS009** Or PS010**	Ceramic Burner Plate S4 Ø1,0mm**  Ceramic Burner Plate S4 Ø1,30mm**	
PS014	Suspension Hook S4 including Nut	
PS015** Or PS016** Or PS017**	Venturi Ø15x6**  Venturi Ø15x8**  Venturi Ø15x11**	
PS023	Burner House S4	
PS035	Set Frame Lists S4	
PS040	Thermocouple Clip S	
PS045	Stone Clip	

PS050	T-piece normal (S types) Incl. 2x PU036 - Screw M5x10 Incl. 1x PU038 - Thumb Screw T-piece M5x30x8	
PU039	Screw M5x16	
PU040	Parker Screw self Tapping	
PU115 Or PU116	Safety Device without Hose Socket Incl. PU117 - Interior Coil Small  Safety Device with Hose Socket Incl. PU117 - Interior Coil Small	
PU117	Magnetic Coil Small	
PU120 Or PU121 Or PU122 Or PU123 Or PU124 Or PU127 Or PU128	Hose Socket 1/8"F 9mm  Hose Socket 1/8"F 11mm  Hose Socket 1/8"F 8mm smooth  Bushing 1/8"F*3/8"M  Bushing 1/8"F*1/2"M  Special Connection Japan  CGA Connection	
PU150	Thermocouple L=220	
PU320 Or PU321	Stainless Steel Filter standard M/S  Filter M/S Heavy Duty	



## Infrared Heater S8

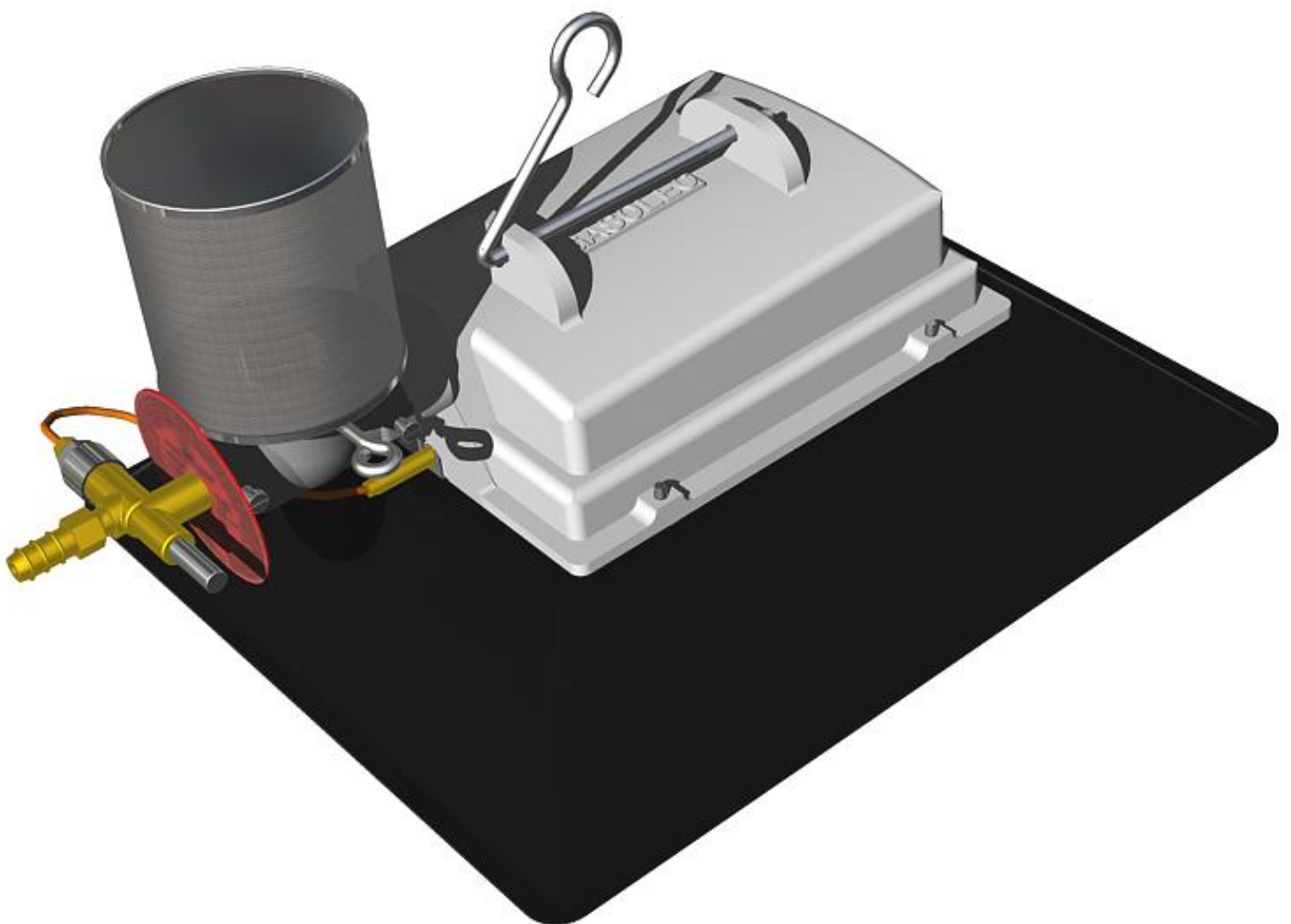

# Infrared Heater S8

**A**

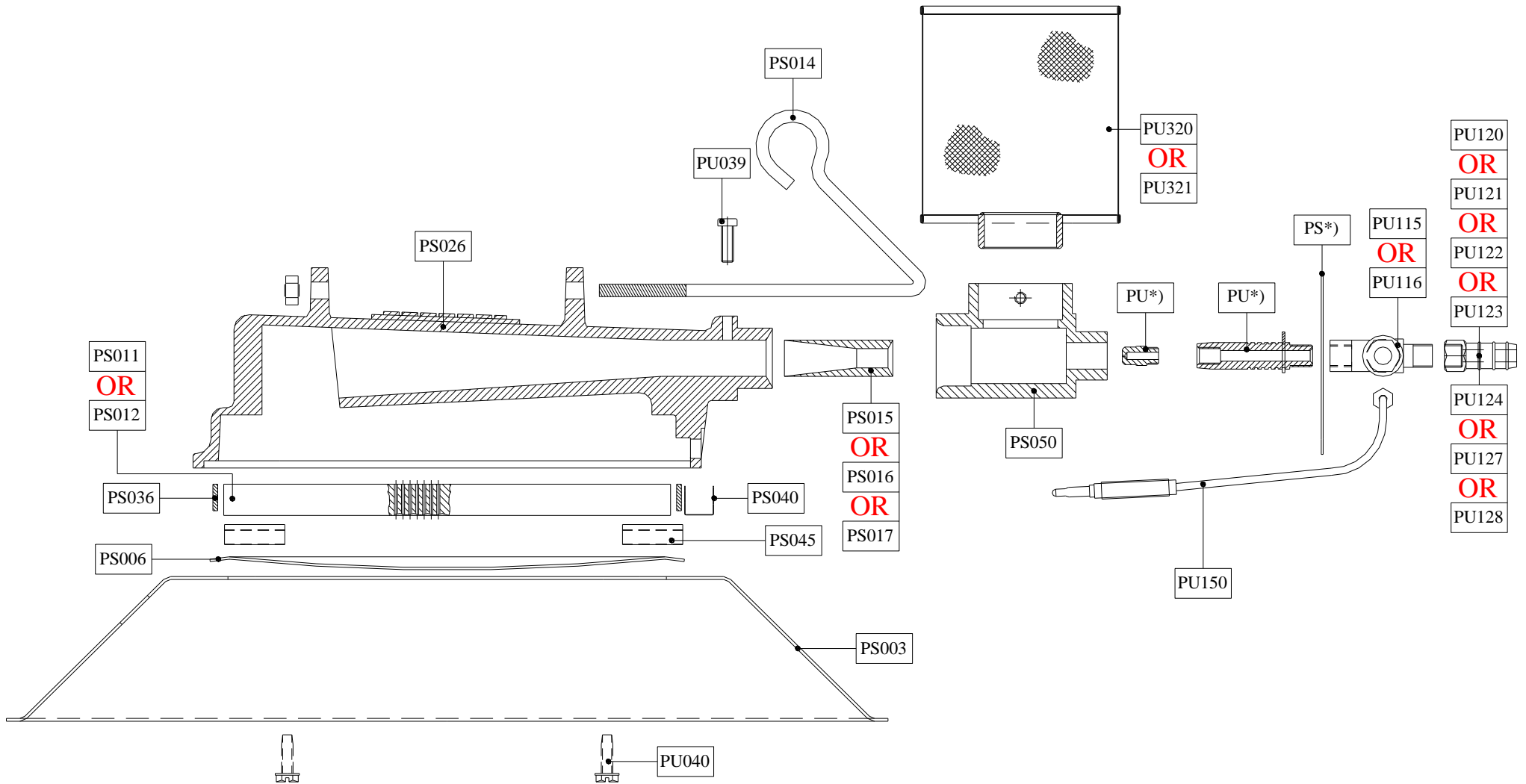



# Infrared Heater S8

**B**

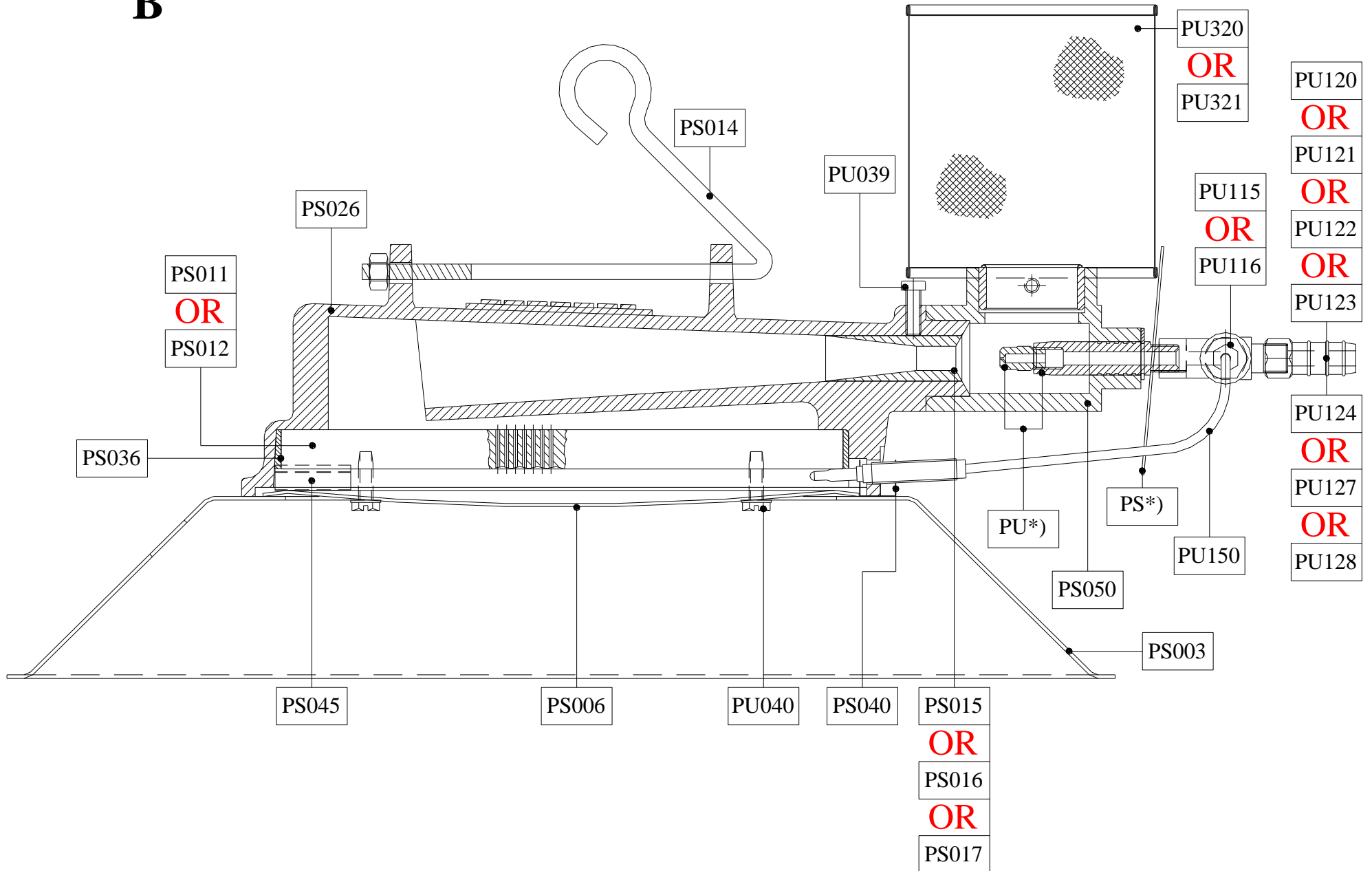

### Parts List S8











Part:	#	Description:	Old Reference:
PU*)	1	Jet S/M, depends on gas type and pressure	9
PU*)	1	Jet Holder S/M, depends on gas type and pressure	10
PS*)	1	Marking Plate S8, depends on gas type and pressure	20
PS003	1	Reflector S8	1
PS006	1	Steel Grid S8	3
PS011** Or PS012**	1	Ceramic Burner Plate S8 Ø1,0mm** Ceramic Burner Plate S8 Ø1,30mm**	4
PS014	1	Suspension Hook S4/S8 including Nut	6
PS015** Or PS016** Or PS017**	1	Venturi Ø15x6** Venturi Ø15x8** Venturi Ø15x11**	16
PS026	1	Burner House S8 Gasolec	5
PS036	1	Set Frame Lists S8	18
PS040	1	Thermocouple Clip S	19
PS045	2	Stone Clip	17
PS050	1	T-piece normal (S types) Incl. 2x PU036 - Screw M5x10 Incl. 1x PU038 - Thumb Screw T-piece M5x30x8	14
PU039	1	Screw M5x16	7
PU040	4	Parker Screw self Tapping	2
PU115  Or PU116	1	Safety Device without Hose Socket Incl. PU117 - Interior Coil Small  Safety Device with Hose Socket Incl. PU117 - Interior Coil Small	11
PU120 Or PU121 Or PU122 Or PU123 Or PU124 Or PU126 Or PU127 Or PU128	1	Hose Socket 1/8"F 9mm Hose Socket 1/8"F 11mm Hose Socket 1/8"F 8mm smooth Bushing 1/8"F*3/8"M Bushing 1/8"F*1/2"M Hose Barb Spanish Special Connection Japan CGA Connection	12
PU150	1	Thermocouple L=220	15
PU320 Or PU321	1	Stainless Steel Filter standard M/S Filter M/S Heavy Duty	8



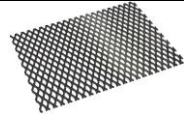
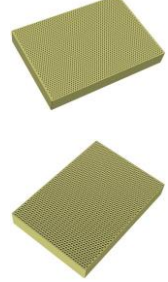



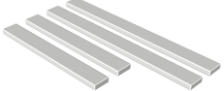

### NOTES:

**PU \*) & PS \*):** Depends on gas type and pressure.

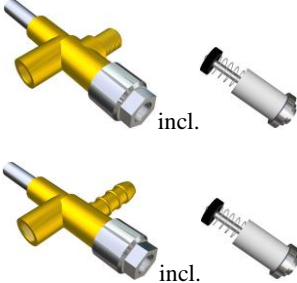
**\*\*:** This also depends on gas type and pressure!

## Infrared Heater S8 Position Numbers

PU*)	Jet S/M, depends on gas type and pressure	
PU*)	Jet Holder S/M, depends on gas type and pressure	
PS*)	Marking Plate S8, depends on gas type and pressure	
PS003	Reflector S8	
PS006	Steel Grid S8	
PS011** Or PS012**	Ceramic Burner Plate S8 Ø1,0mm**  Ceramic Burner Plate S8 Ø1,30mm**	
PS014	Suspension Hook S4/S8 including Nut	
PS015** Or PS016** Or PS017**	Venturi Ø15x6**  Venturi Ø15x8**  Venturi Ø15x11**	
PS026	Burner House S8	
PS036	Set Frame Lists S8	
PS040	Thermocouple Clip S	
PS045	Stone Clip	

PS050	T-piece normal (S types) Incl. 2x PU036 - Screw M5x10 Incl. 1x PU038 - Thumb Screw T-piece M5x30x8	
PU039	Screw M5x16	
PU040	Parker Screw self Tapping	
PU115 Or PU116	Safety Device without Hose Socket Incl. PU117 - Interior Coil Small  Safety Device with Hose Socket Incl. PU117 - Interior Coil Small	
PU117	Magnetic Coil Small	
PU120 Or PU121 Or PU122	Hose Socket 1/8"F 9mm  Hose Socket 1/8"F 11mm  Hose Socket 1/8"F 8mm smooth	
PU123 Or PU124	Bushing 1/8"F*3/8"M  Bushing 1/8"F*1/2"M	
PU127 Or PU128	Special Connection Japan  CGA Connection	
PU150	Thermocouple L=220	
PU320 Or PU321	Stainless Steel Filter standard M/S  Filter M/S Heavy Duty	